





B 206



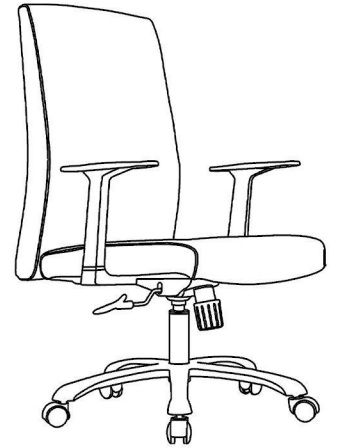
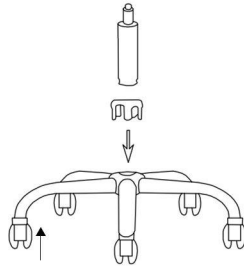
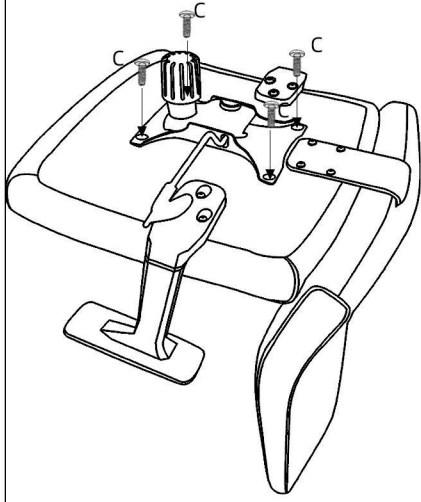
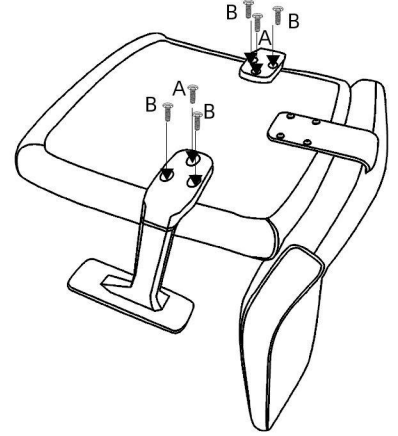
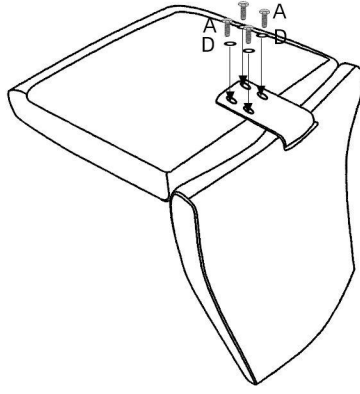

SCREW LIST

A	M6X30		6
B	M6X 35		4
C	M6X 20		4
D	6X20		4
E	M5		1
F			



B 206

SCREW LIST

A	M6X30		6
B	M6X 35		4
C	M6X 20		4
D	6X20		4
E	M5		1
F			

