

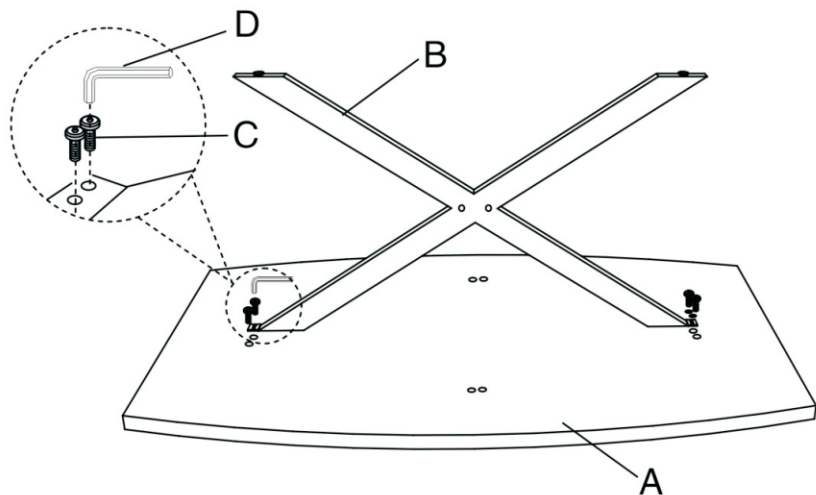

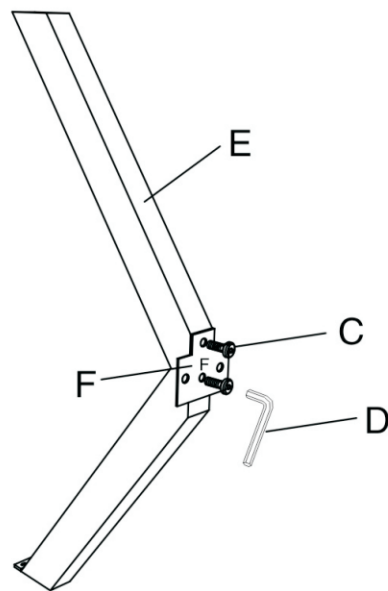



ASSEMBLY INSTRUCTION

1



2



A		1
B		1
C		16
D		1
E		2
F		2

3

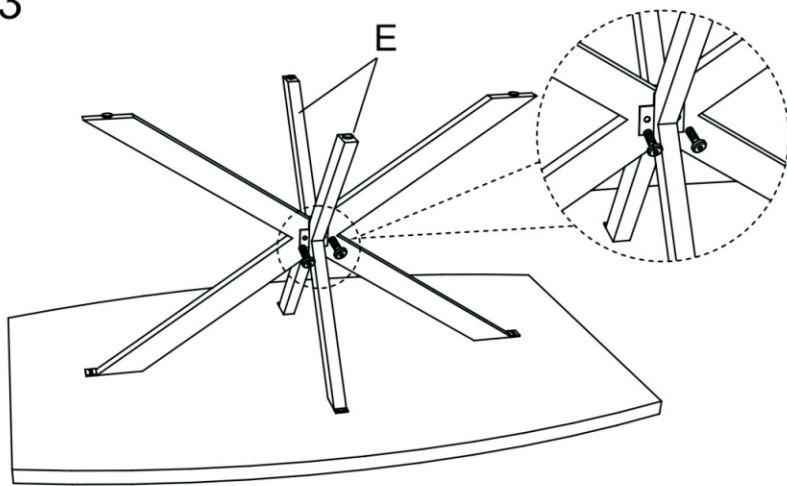

4

